

BOWL+ LAVABO BP080.BI

CE EN 14688:2015

GLOBO



Effetto antibatterico su ceramica
BATAFORM®
Ceramic antibacterial effect
BATAFORM®



Prodotto smaltato con
CERASLIDE®
Glazed product with
CERASLIDE®

Cod. **BP080.BI**

Lavabo 80.50 h 19 cm. Installazione sospesa o su mobile. Completo di fissaggi. Peso 21 Kg
Basin 80.50 h 19 cm. Wall-hung installation or on base. Fixing kit included. Weight 21 Kg

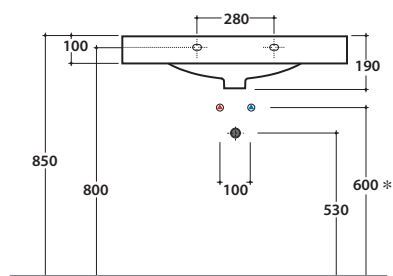
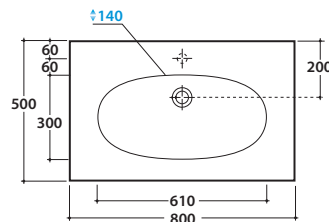

* Per rubinetto su piano / For taps mounted on counter top

Cod. **PB080CR**

Portasciugamani frontale in ottone cromato, peso 0,5 Kg
Front brass chromium-plated towel rail. Weight 0,5 Kg

Cod. **PBLCR**

Portasciugamani laterale in ottone cromato, peso 0,3 Kg
Lateral brass chromium-plated towel rail. Weight 0,3 Kg



Cod. **FI012BI**

Piletta up and down con tappo in ceramica per lavabi con troppo pieno. Peso 0,5 Kg
Push open valve drain with ceramic top for basins with overflow. Weight 0,5 Kg



Cod. **FI012CR**

Piletta cromata up and down per lavabi con troppopieno. Peso 0,5 Kg
Push open chromed valve drain for basins with overflow. Weight 0,5 Kg

Base sospesa 77.49,5 h 48 cm. 1 cassetto. Peso 27 Kg
Wall-hung base 77.49,5 h 48 cm. 1 drawer. Weight 27 Kg

Cod. **BPM3Y**

Salice 904
Betula 905
Smoke 906
Desert 907

Laccati
Laminati rovere laccati
Lacquered
Laminate oak lacquered

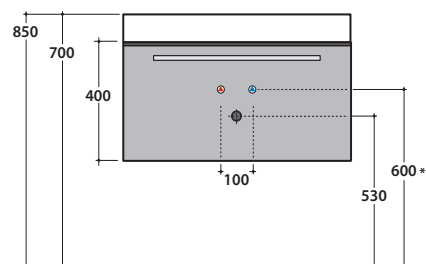
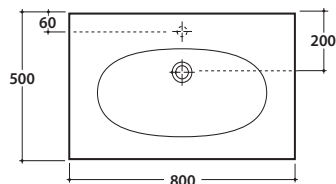
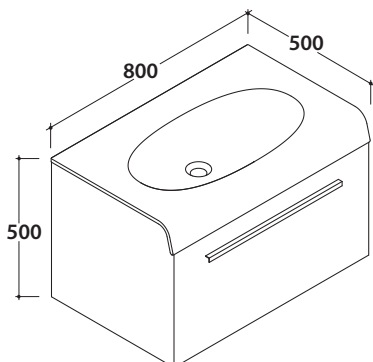

Ingombro massimo con cassetto aperto mm 850
Maximum encumbrance with open drawer 850 mm

* Per rubinetto su piano / For taps mounted on counter top